

VICTORIA'S SECRET

LIGHT BOX ASSEMBLY GUIDE

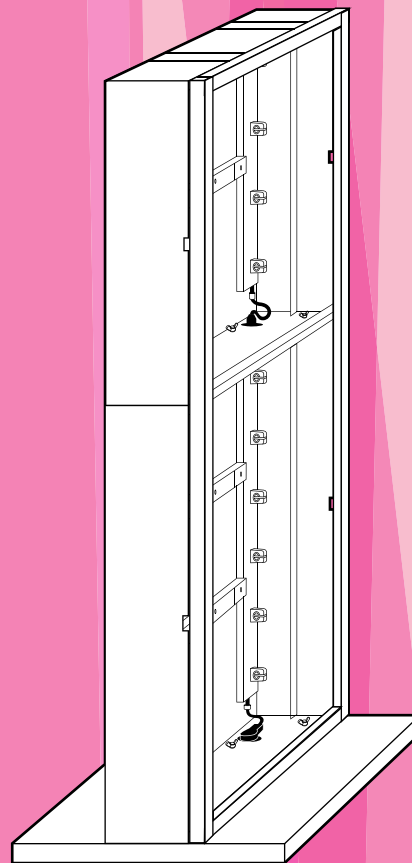
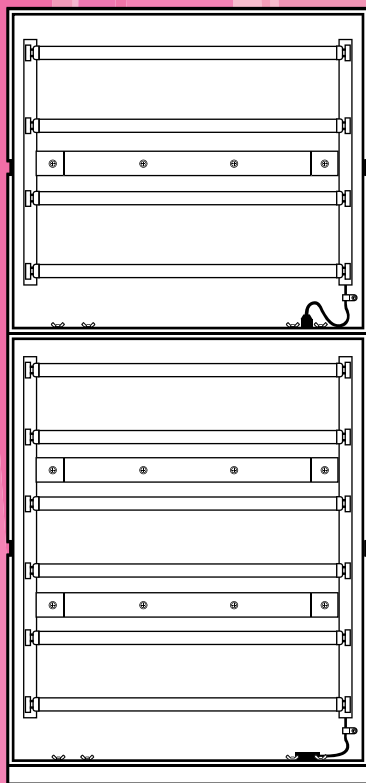

FOR MODELS:
LBX.180
LBX.280
LBX.380
LBX.196
LBX.296
LBX.396

as provided by:



DIGICO IMAGING
innovative printing solutions

3487 East Fulton St. • Columbus, Ohio 43227

phone - 614-239-5200 • 800-288-1191 • fax - 614-231-7281

VICTORIA'S SECRET

PACKAGE CONTENTS

Brackets

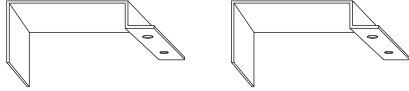

Philips Lamps (x10 for 80" h or x12 for 96" h)

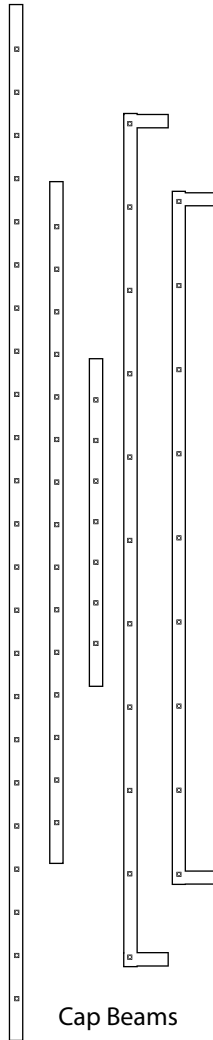
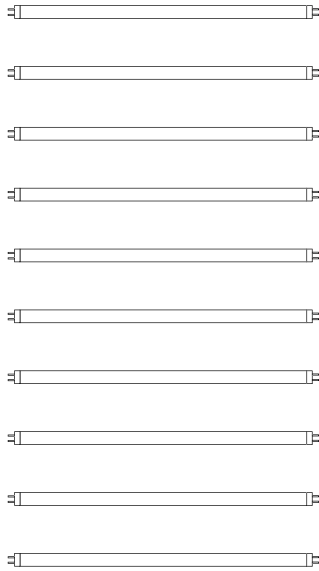

Cap Beams

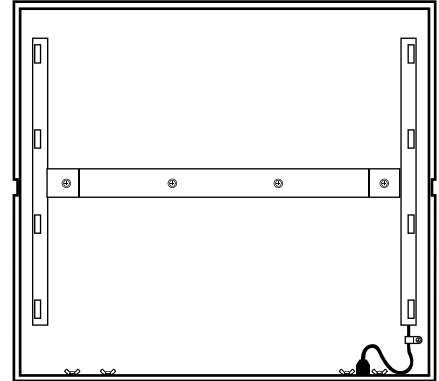

SHORT CABINET (TOP)

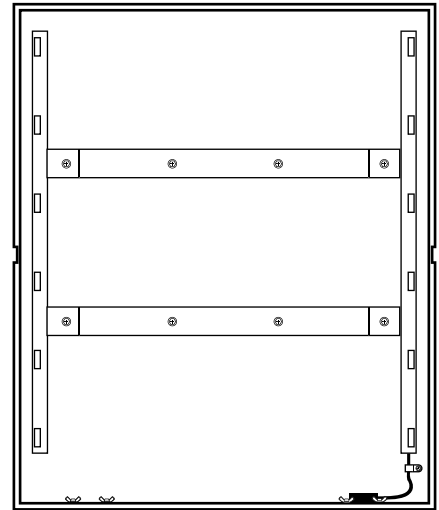

LONG CABINET (BOTTOM)

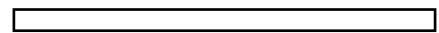

STAND

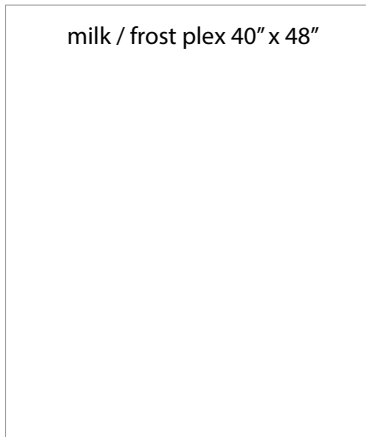

milk / frost plex 40" x 48"

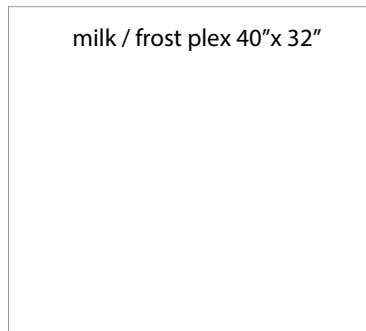

milk / frost plex 40" x 32"

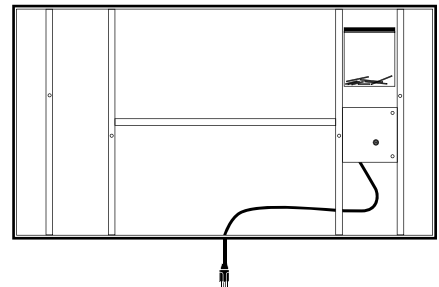

BOTTOM VIEW

VICTORIA'S SECRET

HARDWARE CONTENTS

Actual Size

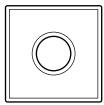

Square Plastic Washer

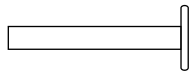

Cap Pin

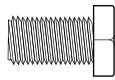

Bracket Screw

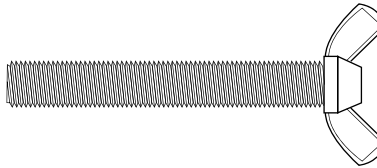

Long Winged Screw

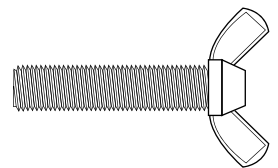

Short Winged Screw

SET-UP INSTRUCTIONS

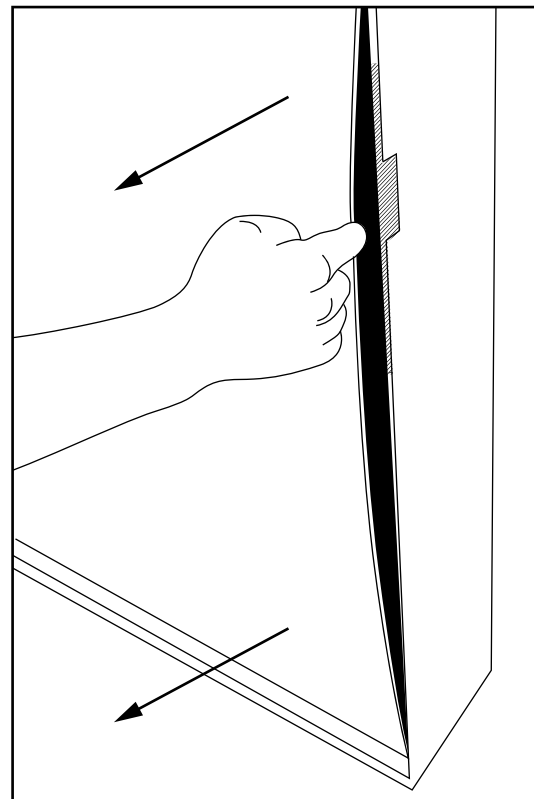
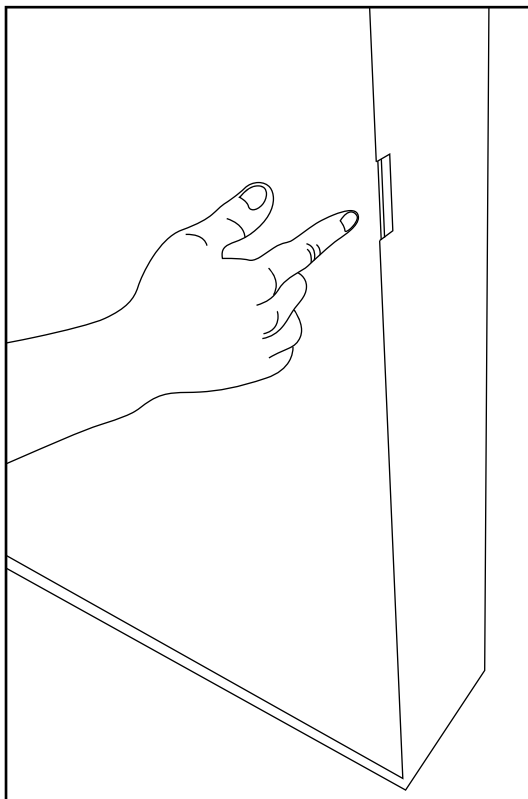

PLEASE NOTE: PLEX WILL COME ATTACHED TO LIGHT BOX COMPONENTS. PLEASE CAREFULLY REMOVE FROM MIDDLE FINGER HOLES WHERE IT IS ATTACHED WITH VELCRO STRIP.

VICTORIA'S SECRET

LIGHT BOX CONSTRUCTION METHOD

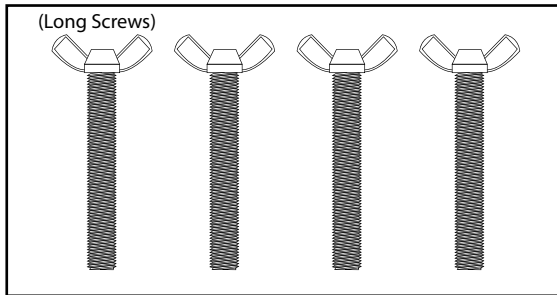

1. Pick up stand and remove screws from packet underneath.

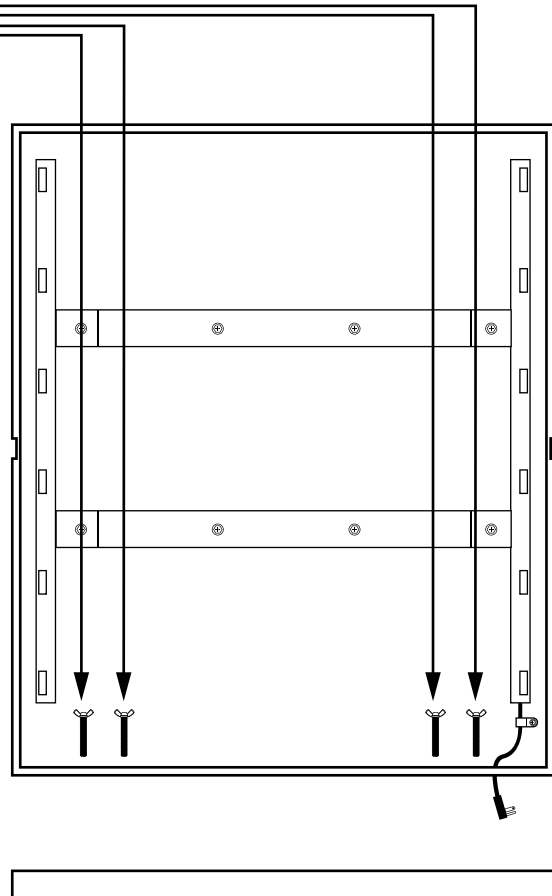
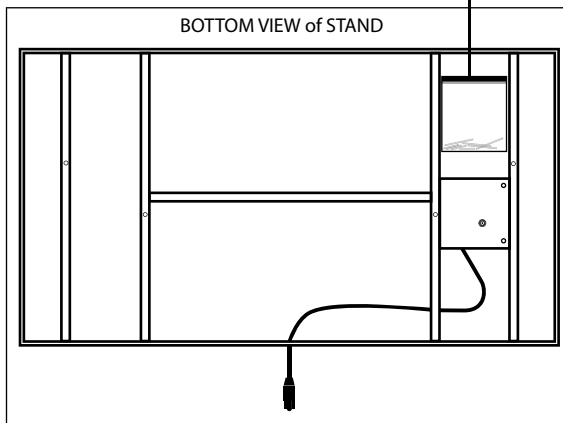

2. Attach bottom lightbox component with long screws x4.

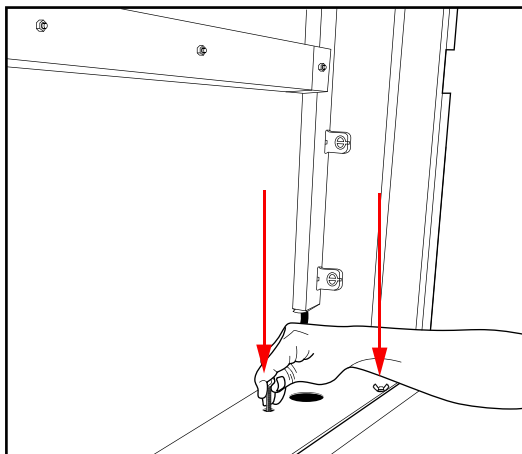

3. Plug into stand after bottom light box component is attached securely.

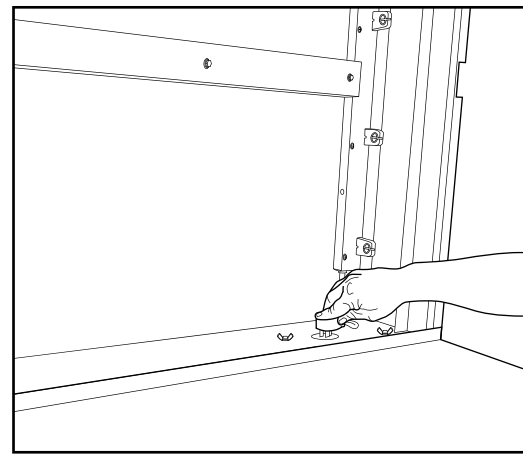

LIGHT BOX CONSTRUCTION METHOD

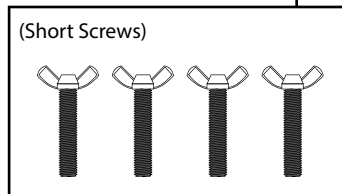
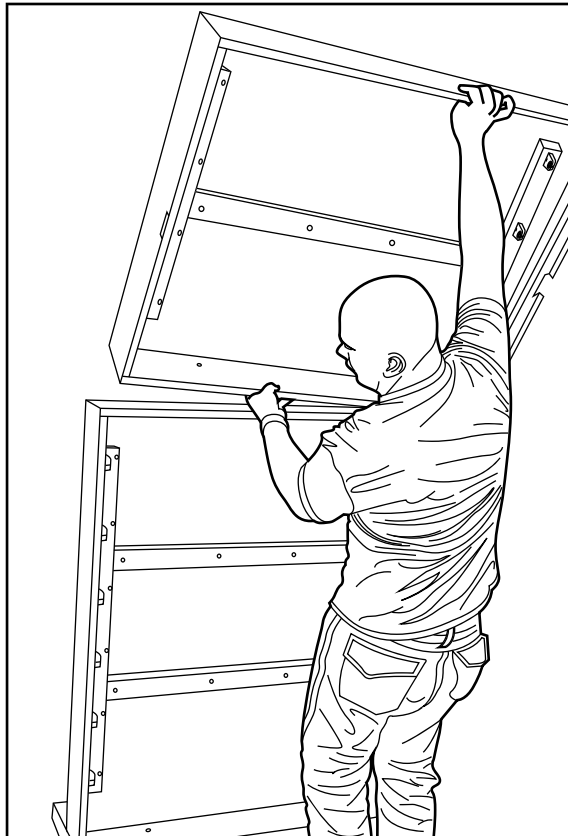

④ Stack upper lightbox on top of bottom lightbox and line up the holes and exterior.

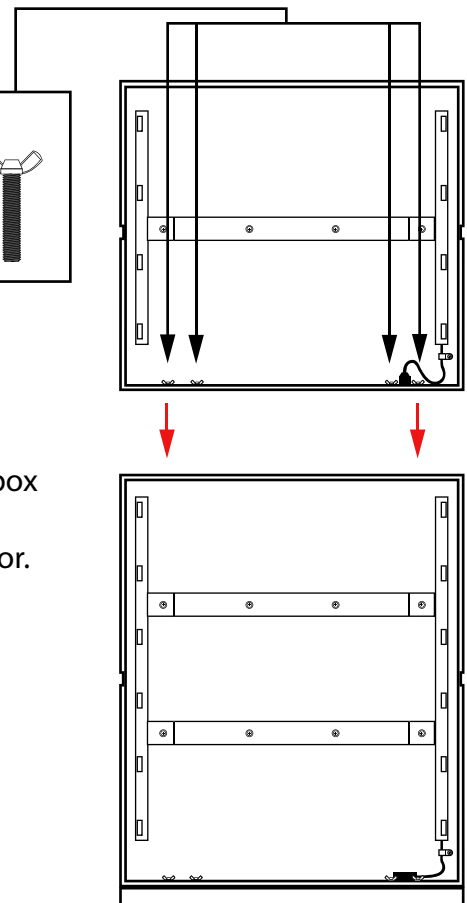

⑤ Use short screws securely to attach top box to lower box.

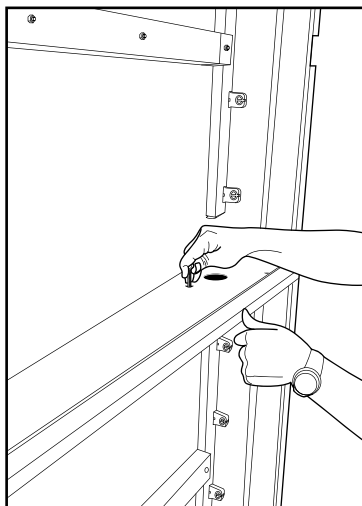

⑥ Attach plug through the attach hole.

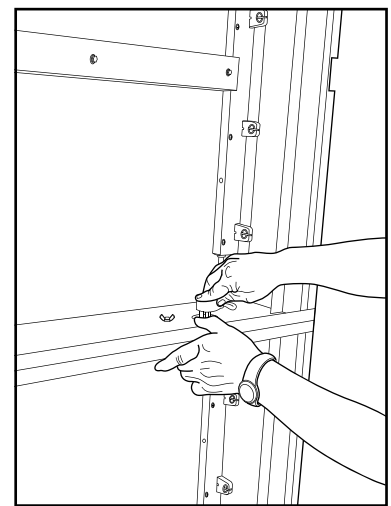

VICTORIA'S SECRET

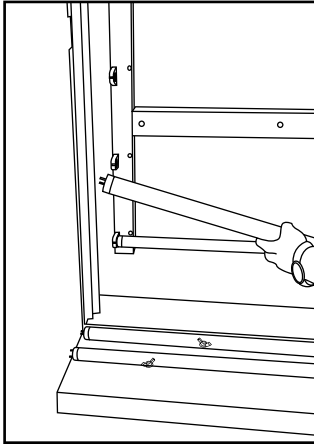

⑦. Install all lights.
The quantity depends
on the light box type.

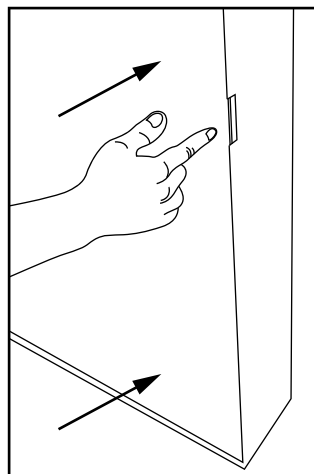
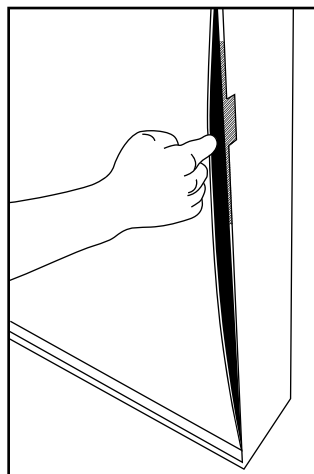
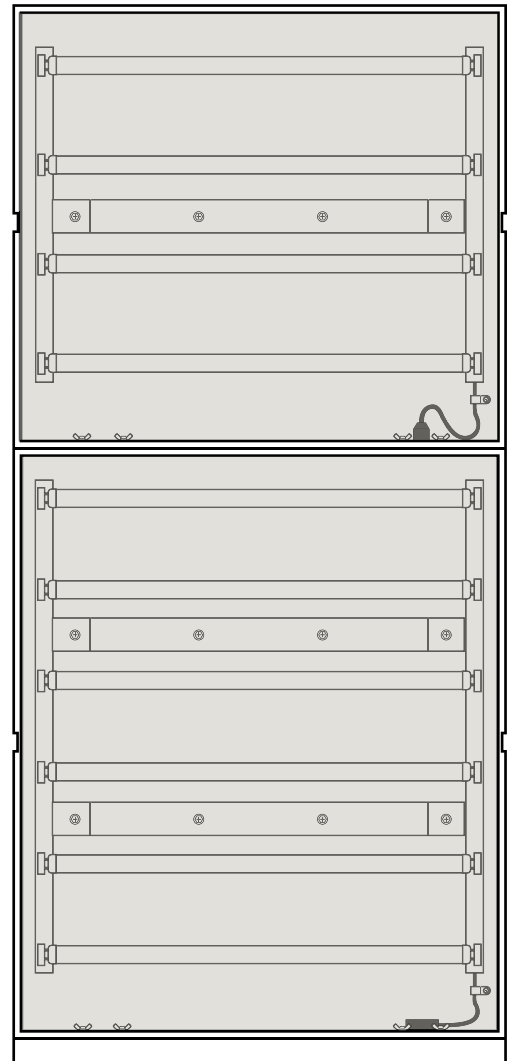

⑧. Re-install plex pieces to fit the proper boxes.

VICTORIA'S SECRET

CAP ASSEMBLY & INSTALATION

TOP BEAM HAS 4 BOLTS FOR BRACKETS

CUT-AWAY ILLUSTRATION

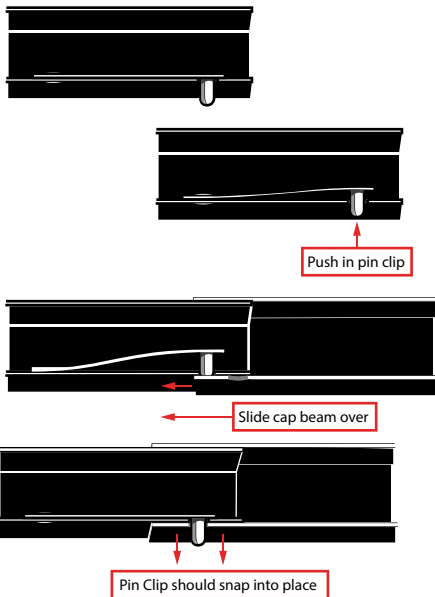

Use your thumb to press the pin clip in. Slide cap beam over the pin clip until it snaps into place.

PUSH PIN DOWN TO SLIDE BOTTOM CAP BEAM. CAP BEAM SHOULD CLICK INTO PLACE.

Brackets

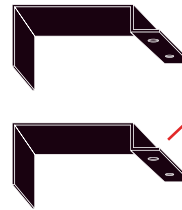

Brackets to be attached to top cap beam to rest on lightbox

FULLY CONSTRUCTED CAP BEAMS

VICTORIA'S SECRET

COMPLETION

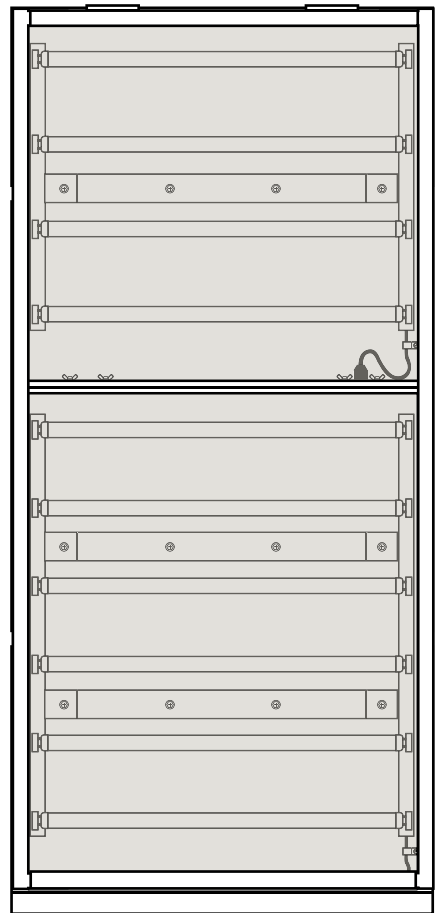
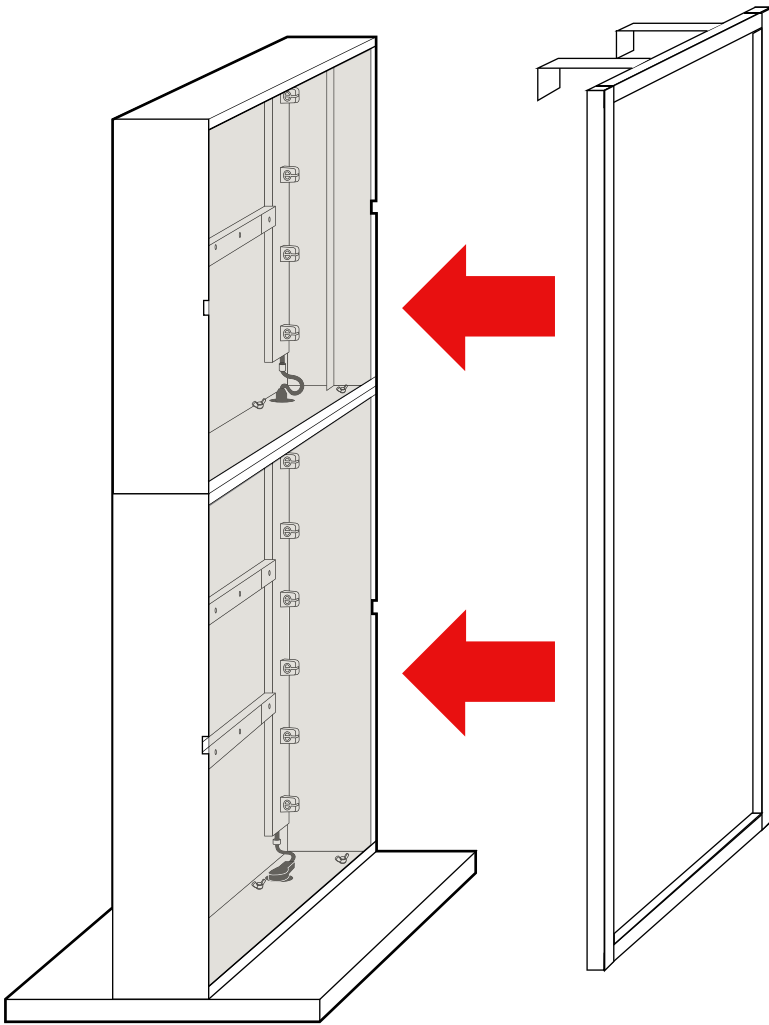

COMPLETED LIGHT BOX

⑨ Hang assembled cap to light box, as shown.